

Accessories

1600 LXP / 1600 LXP/HE

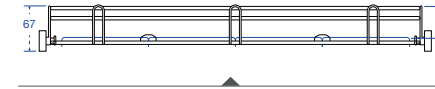

Basic basket with reversible tray lid: Catalog No. PST and GC



Basic basket with spray arm: Catalog No. PSBT



Basket for culture dishes: Catalog No. BP

Baskets

Useful for beakers, trays, dishes, dissolution vessels, funnels, instruments and jars.

1600 LXP

Part number

Basic basket

PST 16

02600084

Basic basket with spray arm

PSBT 16

02600083

Support for culture plates (20 pcs./support max 3 supports) to be used with the PST basket

20 PL

01030417

Basket covers

Accessory basket covers are available to secure small or lightweight labware during the wash cycle.

1600 LXP

Part number

Reversible tray lid for PST/PSBT

GC 16

01030573

Reversible tray lid for injector racks

GCI 16

01030589

Short injectors		
For inside out cleaning of narrow neck glassware, bottles, cylinders, boiling flasks, Erlenmeyer flasks and volumetric flasks.	1600 LXP	Part number
36 short jets, 6 mm diameter	36 IXC 16	02600096
64 short jets, 6 mm diameter	64 IXC 16	02600100
80 short jets, 6 mm diameter	80 IXC 16	02600073
100 short jets, 2 mm diameter	100 IXA 16	02600088
100 short jets, 6 mm diameter	100 IXC 16	02600090
100 short jets, mixed 2 mm and 6 mm diameter	100 IXA/2 16	02600089
144 short jets, 2 mm diameter	144 IXA 16	02600093
144 short jets, 6 mm diameter	144 IXC 16	02600095
144 short jets, mixed 2 mm and 6 mm diameter	144 IXA/2 16	02600094

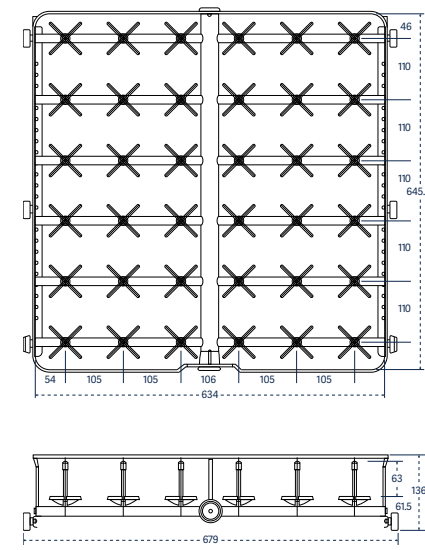

Catalog No. 36 IXC 16

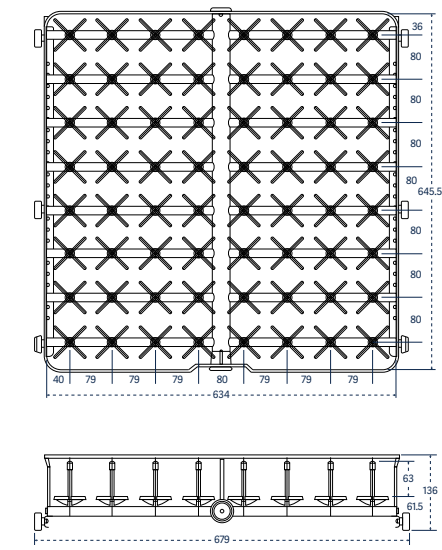

Catalog No. 64 IXC 16

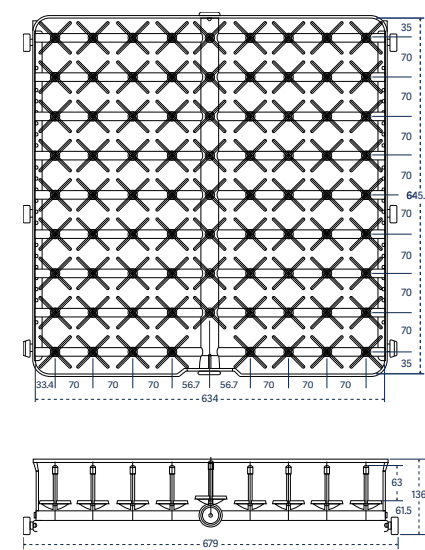

Catalog No. 80 IXC 16

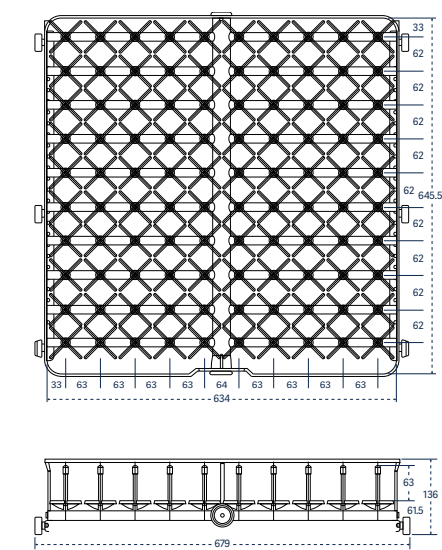

Catalog No. 100 IXA; IXC; IXA/2 16

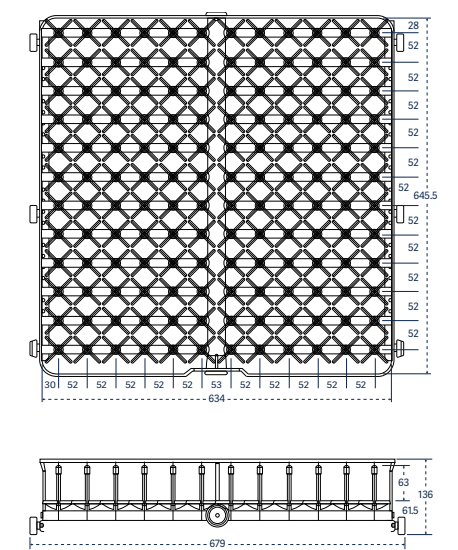

Catalog No. 144 IXA; IXC; IXA/2 16

Long injectors For inside out cleaning of large narrow neck glassware, bottles, cylinders, boiling flasks, Erlenmeyer flasks and volumetric flasks.	1600 LXP	Part number
5 long jets, 12.7 mm diameter, with spray ball	5 IXL 16	02600080
9 long jets, 12.7 mm diameter, with spray ball	9 IXL 16	02600081
12 long jets, 6 mm diameter	12 IXL 16	02600077
36 long jets, 6 mm diameter	36 IXL 16 D6	02600098
36 long jets, 8 mm diameter	36 IXLC 16	02600097
64 long jets, 6 mm diameter	64 IXL 16	02600101
80 long jets, 6 mm diameter	80 IXL 16	02600104
100 long jets, 6 mm diameter	100 IXL 16	02600091

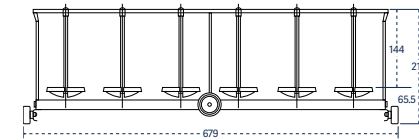
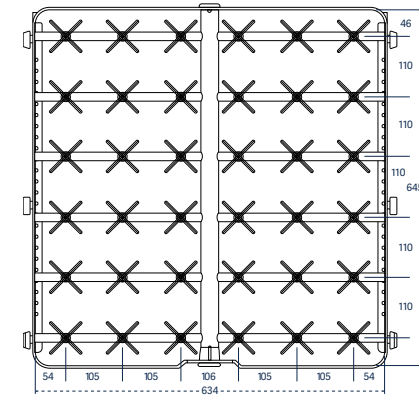

Catalog No. 36 IXL 16 D6

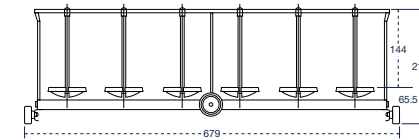
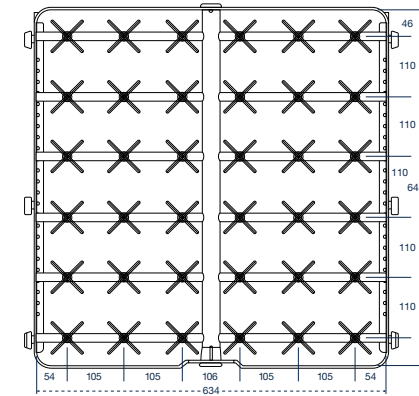

Catalog No. 36 IXL 16

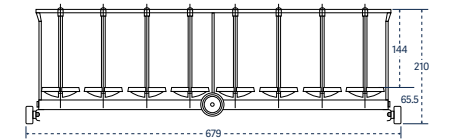
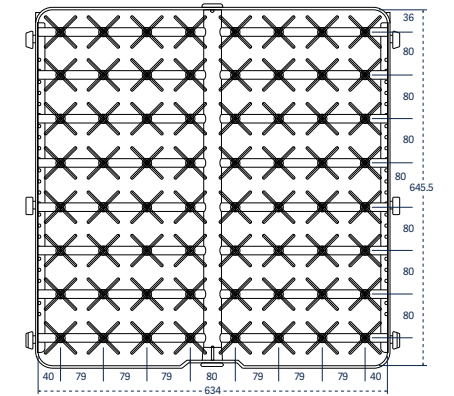

Catalog No. 64 IXL 16

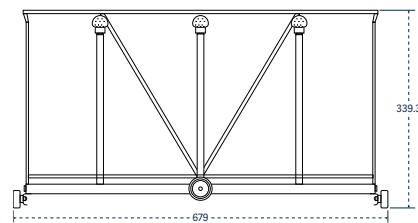
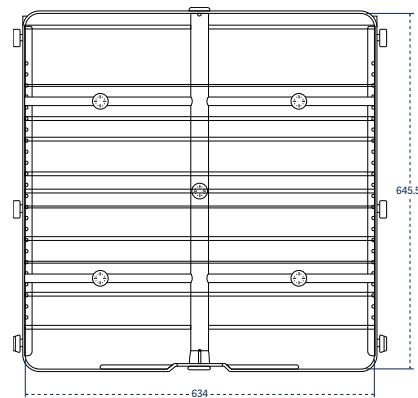

Catalog No. 5 IXL 16

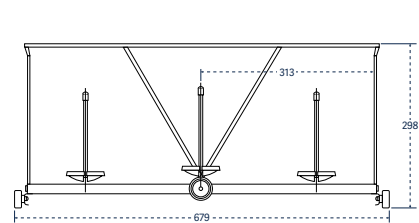
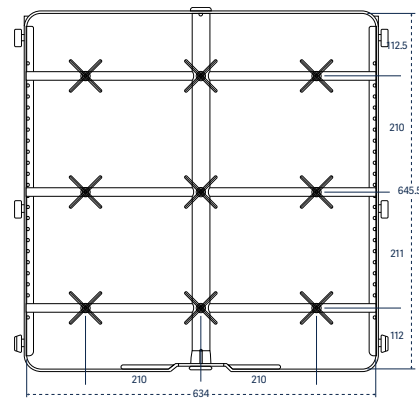

Catalog No. 9 IXL 16

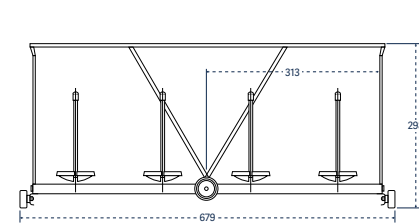
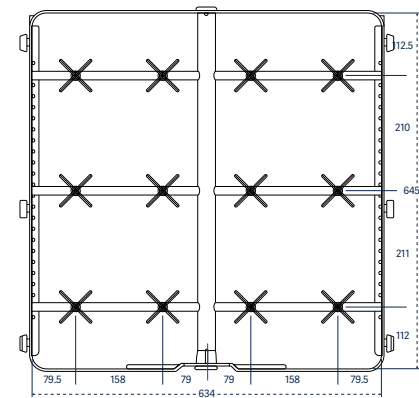

Catalog No. 12 IXL 16

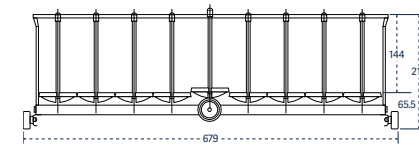
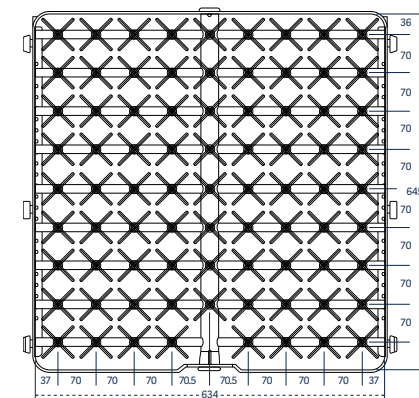

Catalog No. 80 IXL 16

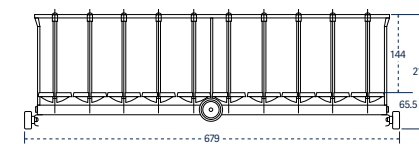
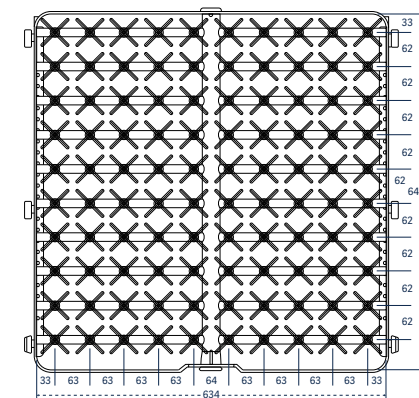

Catalog No. 100 IXL 16

Extra long injectors, 12" (305 mm) tall
 For inside out cleaning of narrow neck glassware, bottles, cylinders, boiling flasks, Erlenmeyer flasks and large volumetric flasks.

	1600 LXP	Part number
1 long jet, 12.7 mm diameter, with spray ball	1 IXL 16	02600076
2 long jets, 12.7 mm diameter, with spray ball	2 IXL 16	02600078
4 long jets, 12.7 mm diameter, with spray ball	4 IXL 16	02600079

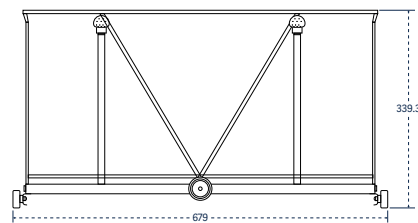
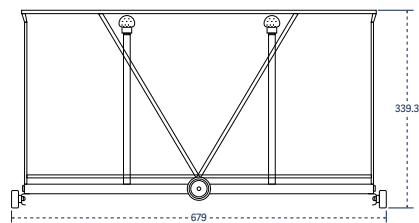
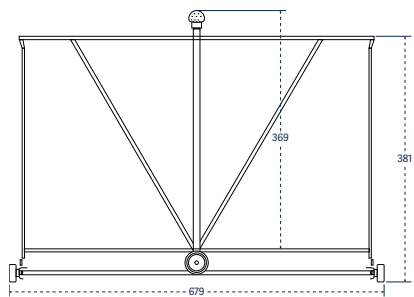
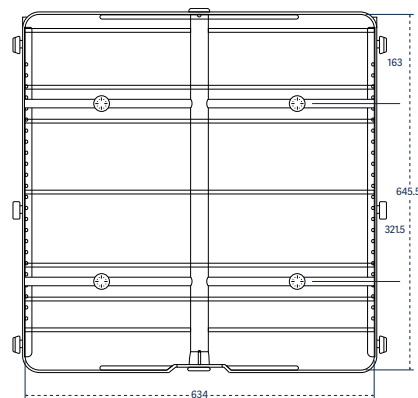
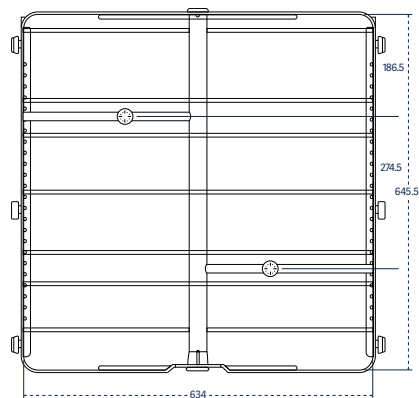
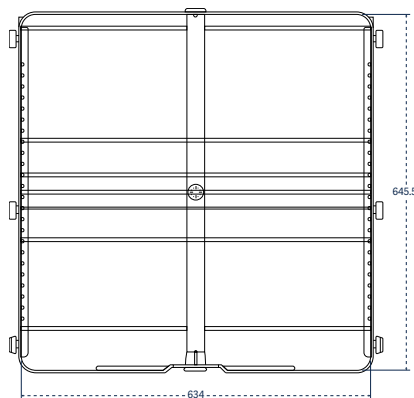

Catalog No. 1 IXL 16

Catalog No. 2 IXL 16

Catalog No. 4 IXL 16

Combination short/long injectors
 For inside out cleaning of mixed loads of narrow neck glassware, bottles, cylinders, boiling flasks, Erlenmeyer flasks and volumetric flasks.

	1600 LXP	Part number
36 short and long jets, 6 mm diameter	36 IXLC 16	02600099
64 short and long jets, 6 mm diameter	64 IXLC 16	02600102
80 short and long jets, 6 mm diameter	80 IXLC 16	02600105
100 short and long jets, 6 mm diameter	100 IXLC 16	02600092

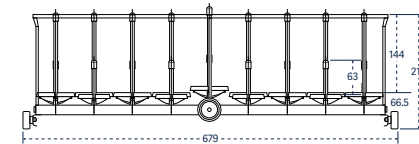
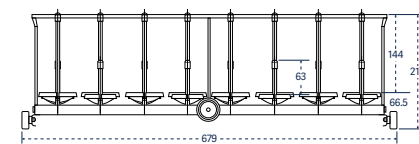
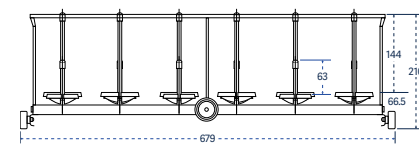
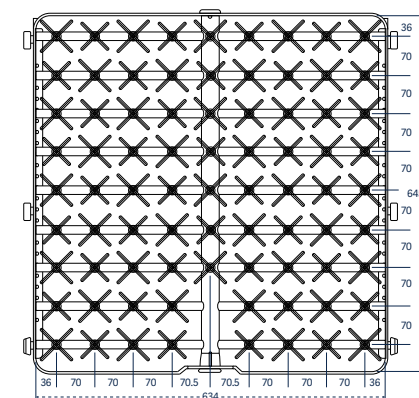
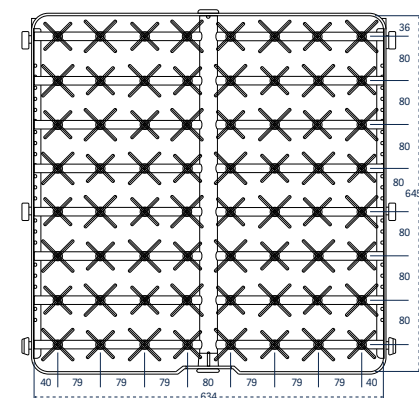
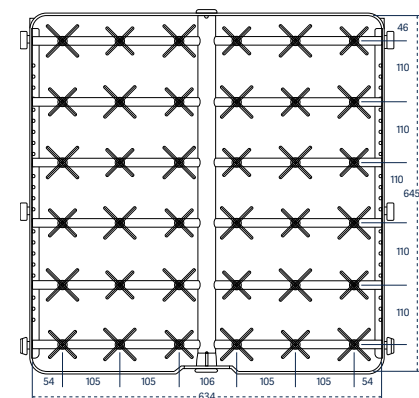

Catalog No. 36 IXLC 16

Catalog No. 64 IXLC 16

Catalog No. 80 IXLC 16

