

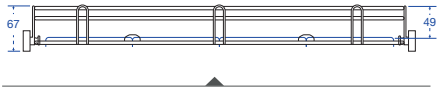

# Accessories

1600 LXP / 1600 LXP/HE





Basic basket with reversible tray lid:  
Catalog No. PST and GC



Basic basket with spray arm: Catalog No.  
PSBT



Basket for culture dishes: Catalog No. BP

### Baskets

Useful for beakers, trays, dishes, dissolution vessels, funnels, instruments and jars.

**1600 LXP**

**Part number**

#### Basic basket

PST 16

02600084

#### Basic basket with spray arm

PSBT 16

02600083

#### Support for culture plates (20 pcs./support max 3 supports) to be used with the PST basket

20 PL

01030417

### Basket covers

Accessory basket covers are available to secure small or lightweight labware during the wash cycle.

**1600 LXP**

**Part number**

#### Reversible tray lid for PST/PSBT

GC 16

01030573

#### Reversible tray lid for injector racks

GCI 16

01030589

<b>Short injectors</b> For inside out cleaning of narrow neck glassware, bottles, cylinders, boiling flasks, Erlenmeyer flasks and volumetric flasks.	<b>1600 LXP</b>	<b>Part number</b>
<b>36 short jets, 6 mm diameter</b>	36 IXC 16	02600096
<b>64 short jets, 6 mm diameter</b>	64 IXC 16	02600100
<b>80 short jets, 6 mm diameter</b>	80 IXC 16	02600073
<b>100 short jets, 2 mm diameter</b>	100 IXA 16	02600088
<b>100 short jets, 6 mm diameter</b>	100 IXC 16	02600090
<b>100 short jets, mixed 2 mm and 6 mm diameter</b>	100 IXA/2 16	02600089
<b>144 short jets, 2 mm diameter</b>	144 IXA 16	02600093
<b>144 short jets, 6 mm diameter</b>	144 IXC 16	02600095
<b>144 short jets, mixed 2 mm and 6 mm diameter</b>	144 IXA/2 16	02600094



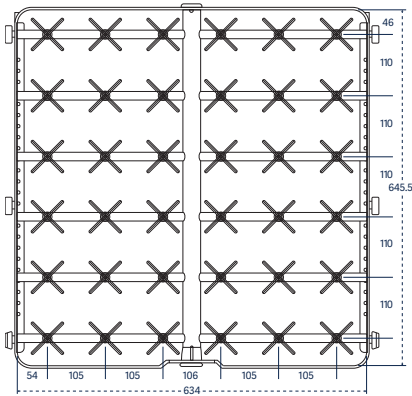

Catalog No. 36 IXC 16

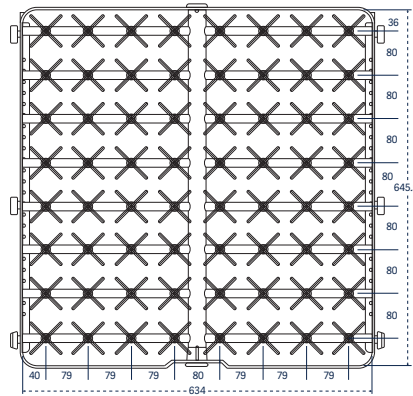

Catalog No. 64 IXC 16

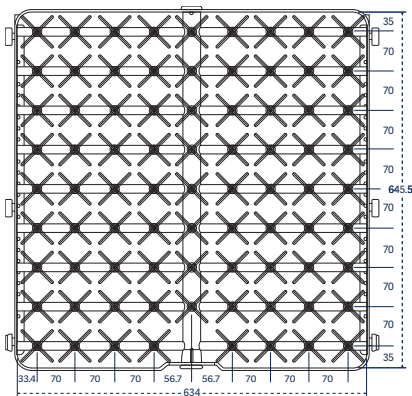

Catalog No. 80 IXC 16

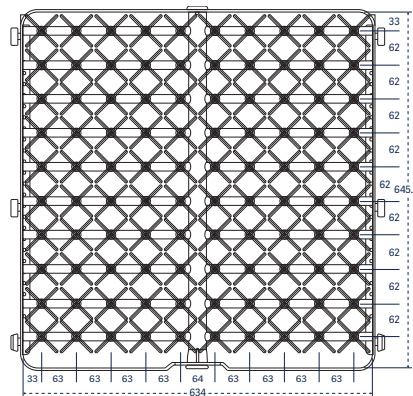

Catalog No. 100 IXA; IXC; IXA/2 16

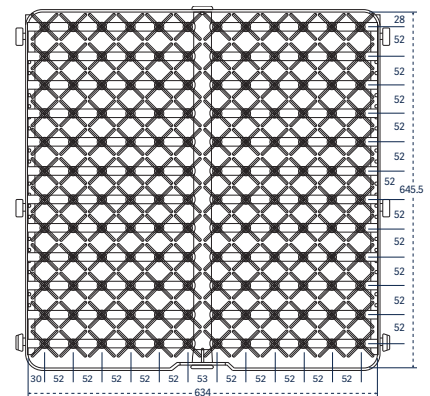

Catalog No. 144 IXA; IXC; IXA/2 16

### Long injectors

For inside out cleaning of large narrow neck glassware, bottles, cylinders, boiling flasks, Erlenmeyer flasks and volumetric flasks.

1600 LXP

Part number

5 long jets, 12.7 mm diameter, with spray ball

5 IXL 16

02600080

9 long jets, 12.7 mm diameter, with spray ball

9 IXL 16

02600081

12 long jets, 6 mm diameter

12 IXL 16

02600077

36 long jets, 6 mm diameter

36 IXL 16 D6

02600098

36 long jets, 8 mm diameter

36 IXLC 16

02600097

64 long jets, 6 mm diameter

64 IXL 16

02600101

80 long jets, 6 mm diameter

80 IXL 16

02600104

100 long jets, 6 mm diameter

100 IXL 16

02600091

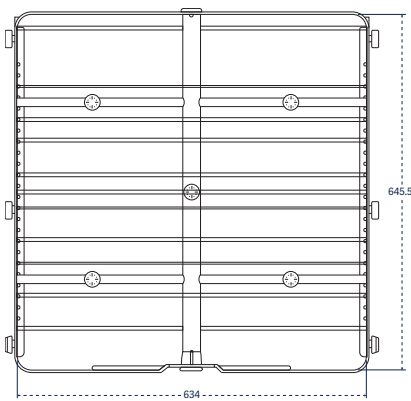

Catalog No. 5 IXL 16

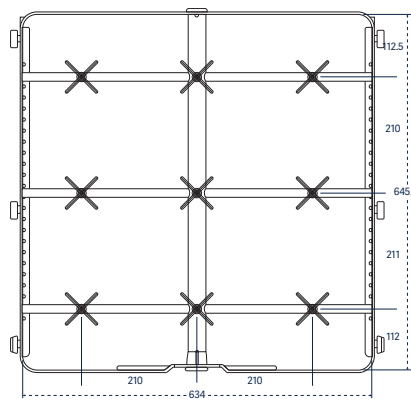

Catalog No. 9 IXL 16

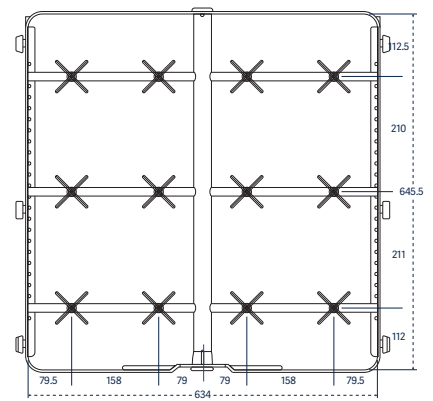

Catalog No. 12 IXL 16

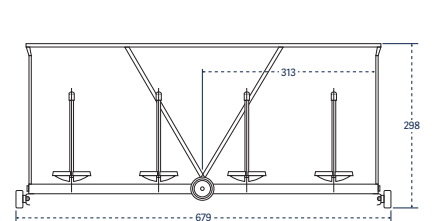
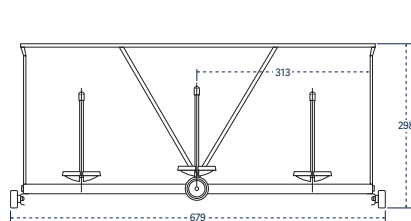
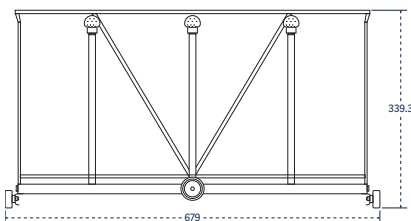

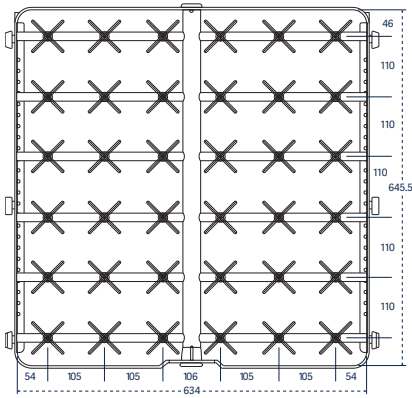

Catalog No. 36 IXL 16 D6

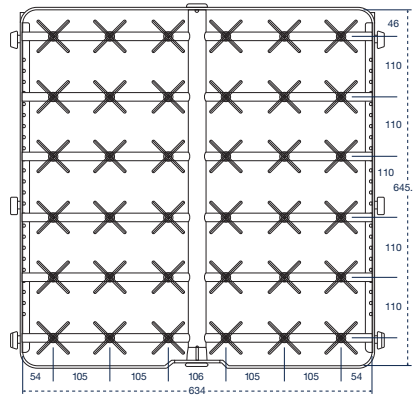

Catalog No. 36 IXL 16

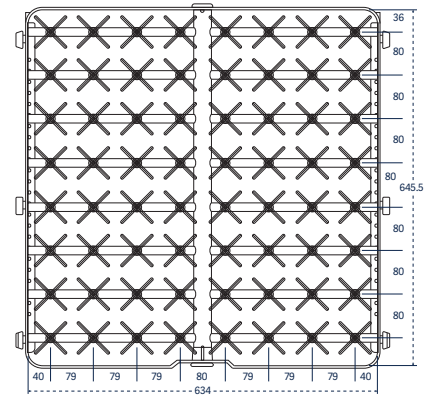

Catalog No. 64 IXL 16

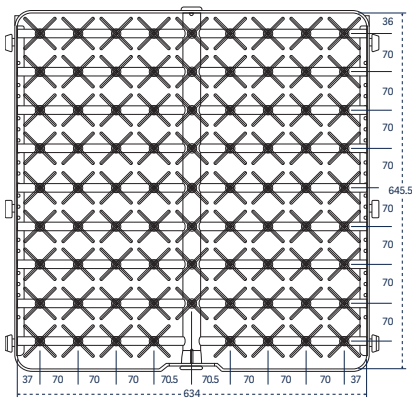

Catalog No. 80 IXL 16

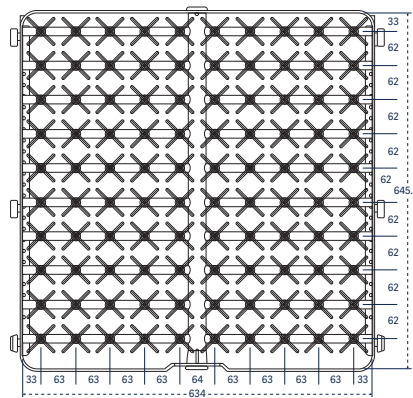

Catalog No. 100 IXL 16

**Extra long injectors, 12" (305 mm) tall**

For inside out cleaning of narrow neck glassware, bottles, cylinders, boiling flasks, Erlenmeyer flasks and large volumetric flasks.

**1600 LXP**

**Part number**

**1 long jet, 12.7 mm diameter, with spray ball**

1 IXL 16

02600076

**2 long jets, 12.7 mm diameter, with spray ball**

2 IXL 16

02600078

**4 long jets, 12.7 mm diameter, with spray ball**

4 IXL 16

02600079

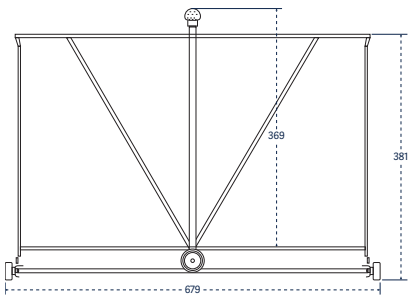
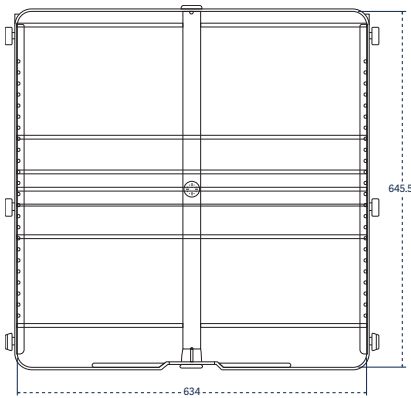

Catalog No. 1 IXL 16

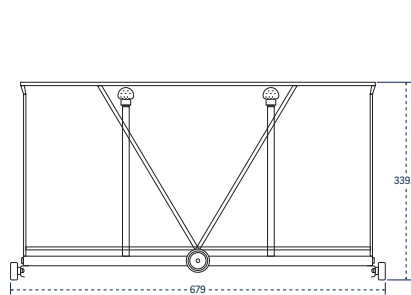
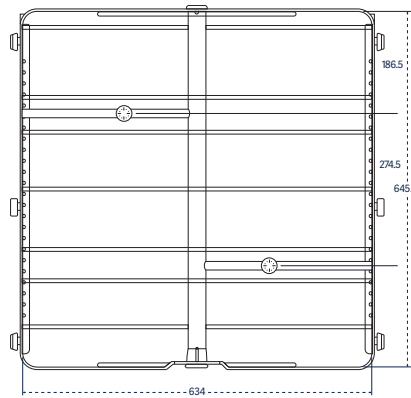

Catalog No. 2 IXL 16

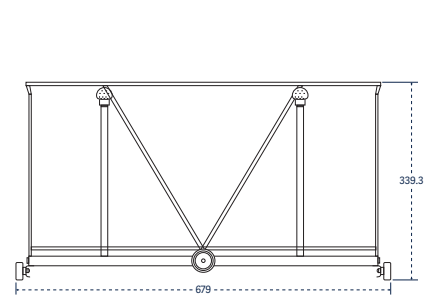
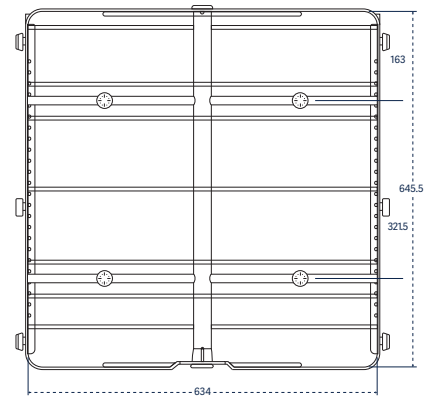

Catalog No. 4 IXL 16

### Combination short/long injectors

For inside out cleaning of mixed loads of narrow neck glassware, bottles, cylinders, boiling flasks, Erlenmeyer flasks and volumetric flasks.

1600 LXP

Part number

36 short and long jets, 6 mm diameter

36 IXLC 16

02600099

64 short and long jets, 6 mm diameter

64 IXLC 16

02600102

80 short and long jets, 6 mm diameter

80 IXLC 16

02600105

100 short and long jets, 6 mm diameter

100 IXLC 16

02600092

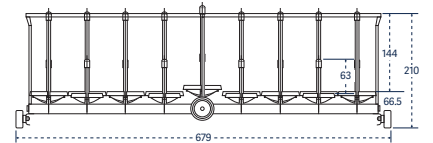
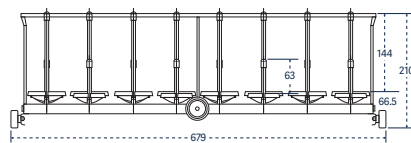
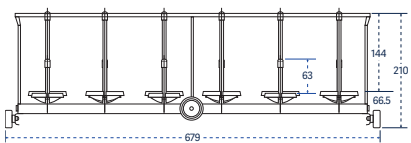
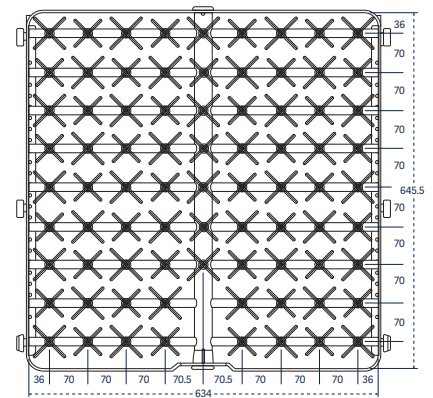
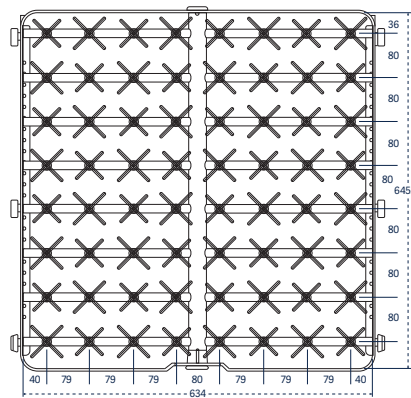
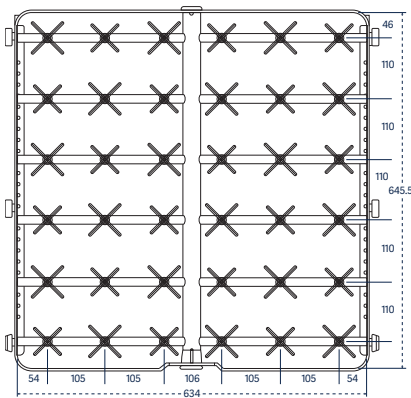

Catalog No. 36 IXLC 16

Catalog No. 64 IXLC 16

Catalog No. 80 IXLC 16



### Pipette racks

Accessory pipette racks are configured to accommodate reusable pipettes.

1600 LXP

Part number

Grommet style, individually loaded, 105 position

105 PIP 14

02600106

### Bioreactor rack

1600 LXP

Part number

Rack for 0.26-0.79 gal (1-3 L) Bioreactors

BRWR 16

AA02600115

### Storage stand

An accessory storage stand offers a convenient place to store accessory racks and baskets when not in use.

1600 LXP

Part number

Holds up to 5 racks

RP 16

01040063

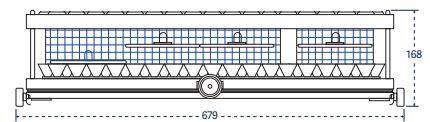
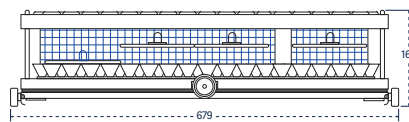
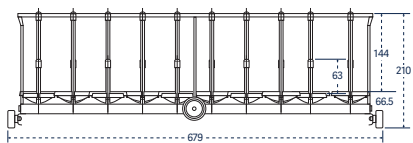
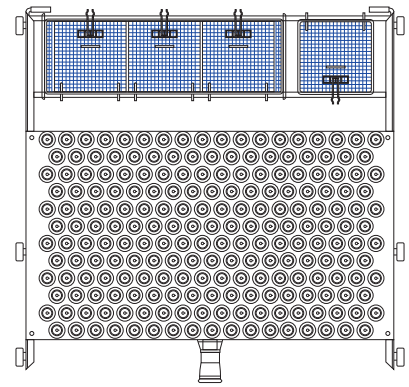
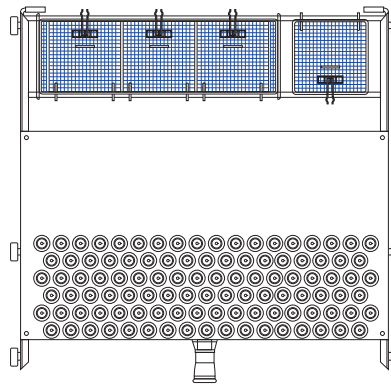
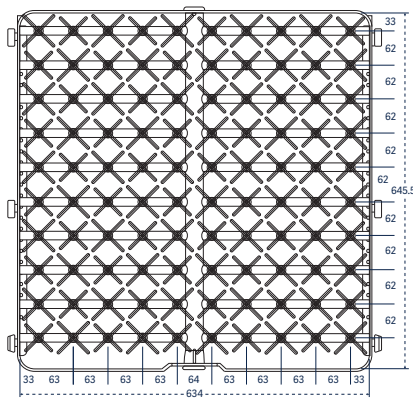

Catalog No. 100 IXLC 16

Catalog No. 105 PIP 16

Catalog No. 210 PIP 16

### Injector KIT packages

KIT enable customization of standard injector racks to fit specific needs. Each KIT include 10 complete injectors with their supports and nozzles.

	Part number
Long injectors, length of 230 mm and 6 mm diameter	6007500984
Long injectors, length of 171 mm and 6 mm in diameter	6007500890
Short injectors, length of 86 mm and 6 mm in diameter	6007500957
Short injectors, length of 56 mm and 6 mm in diameter	6007501012
Long injectors, length of 171 mm and 8 mm in diameter	6007501011
Needle injectors, length of 86 mm	6007501007

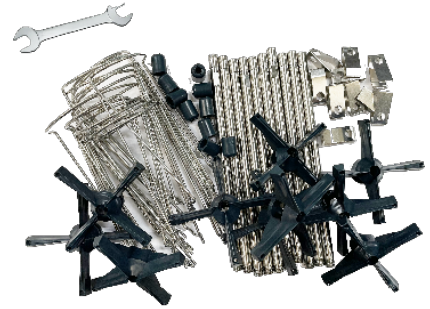

### Trolley

The stainless steel loading trolley transfers the load and mates with the washer to simplify loading and unloading. The trolley includes a retainer lip to keep the floor dry from residual water. Includes locking casters.

1600 LXP

Part number

Trolley, 4 levels

TN 16

02530020

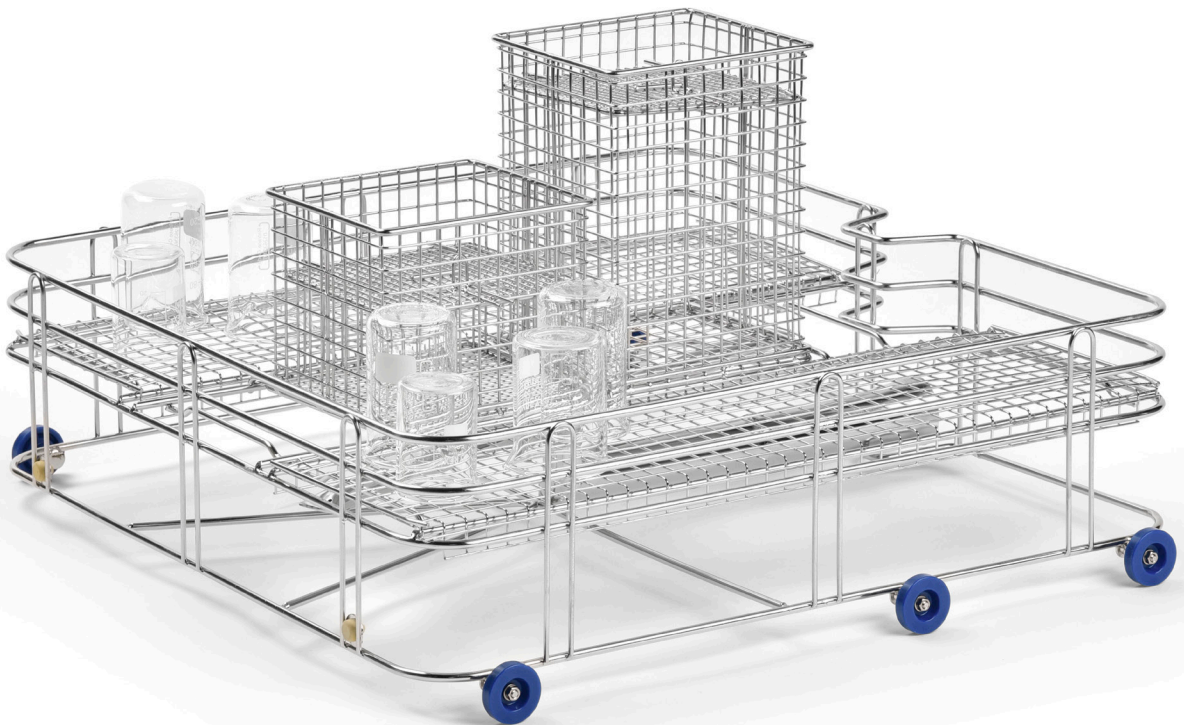



Getinge is a global provider of innovative solutions for Life Science companies and institutions, operating rooms, intensive care units and sterilization departments. Based on our firsthand experience and close partnerships with Life Science companies, clinical experts, healthcare professionals and medtech specialists, we are improving everyday life for people – today and tomorrow.

This document is intended to provide information to a North American audience.

**Getinge USA Sales · LLC 1150 Emma Oaks Trail Suite 140 · Lake Mary FL 32746 · USA**  
**Phone: 1-800-332-1855 · E-mail: [Sales.lancer@getinge.com](mailto:Sales.lancer@getinge.com)**

[www.getinge.com/US](http://www.getinge.com/US)