

**Product Data Sheet**

Upright 16 cu. ft. Glass Door Refrigerator, High Performance  
 - Certified to NSF/ANSI 456 Standard for Vaccine Storage

**Certifications**



Intertek

\*-one or more of these certifications may apply to this unit.

**Product Description**

These cutting-edge pharmacy refrigerators are certified in accordance with the NSF/ANSI 456 Standard for Vaccine Storage. With this certification, units protect pharmaceuticals at optimal temperatures, preventing waste and allowing for peak delivery.

These glass door refrigerators utilize microprocessor controllers and feature temperature alarms, remote alarm contacts, and probe access ports with included probes. Units run on natural, hydrocarbon refrigerant for environmental health and energy efficiency.

**General Description and Application**

Description	Single Glass Door Pharmacy/Vaccine Upright Refrigerator
Operational environment	Indoor use only, +18°C to +26°C (+65°F to +78°F), <70% RH
Storage capacity	16 cu. ft. gross volume
Door	One swing glass door, self-closing, right hinged, non-reversible, magnetic sealed gasket, keyed lock
Shelves	Four shelves (three adjustable/one fixed) with guard rail on back
Mounting	3 1/2" Swivel Casters(two locking)
Interior lighting	Shielded, switched LED lighting, full coverage, balanced spectrum
Airflow management	Forced Air technology, patent pending
External probe access	Rear wall port (3/4") dia.
Insulation	Cabinet is foamed-in-place with EPA compliant high density urethane foam
Exterior materials	White powder coated steel
Access control	Pyxis®, Omnicell® and AcuDose RX® compatible
General warranty	One (1) year parts and labor warranty, excluding display probe calibration
Compressor warranty	Five(5) years compressor warranty
Product Weight	249
Shipping Weight	289
Rated Amperage	3
Power Plug/Power Cord	NEMA 5-15 plug, 8 to 10 ft typical, conforms to UL471 requirements, Vaccine Storage power 110-120V AC: 15 A (minimum)
Facility Electrical Requirement	
Agency Listing and Certification	Certified with the temperature performance requirements as defined in the NSF/ANSI 456 Standard for Vaccine Storage for all testing scenarios. UL, C-UL, ETL, C-ETL listed and certified to UL471 standard, hydrocarbon refrigerant safety. Energy Star Certified
Included Accessories	Temperature monitor device (TMD) complies with the current CDC guidelines, with 3 years certification of calibration, "buffered" probe in the product simulated solution, min/max memory, field installable, and visual & audible temp alarm  Pharmacy refrigerator/freezer toolkit and temperature logs

**Temperature Probes**

Probe	Ave	Min	Max
1	4.3	3.4	5.4
2	4.6	4.2	5.2
3	4.7	4.4	5.2
4	4.6	4.1	5.4
5	4.6	4.2	5.3
6	4.3	3.7	5.3
7	4.6	4.3	5.2
8	4.7	4.3	5.4
9	4.7	4.1	5.6
10	4.6	4.2	5.3
11	4.6	3.8	5.7
12	4.5	3.9	5.3
13	4.7	4.4	5.1
14	5.4	5.1	5.9
15	4.3	3.5	5.4

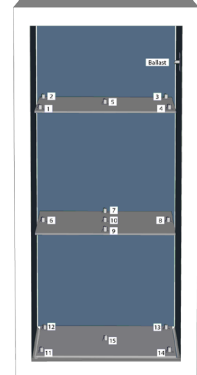

**Temperature Charts**

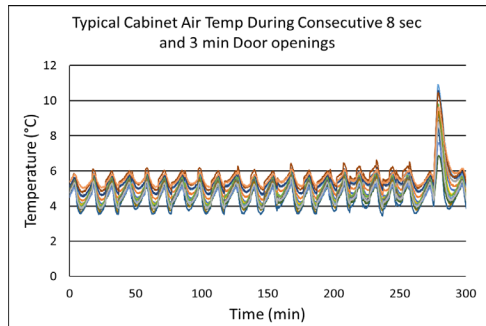
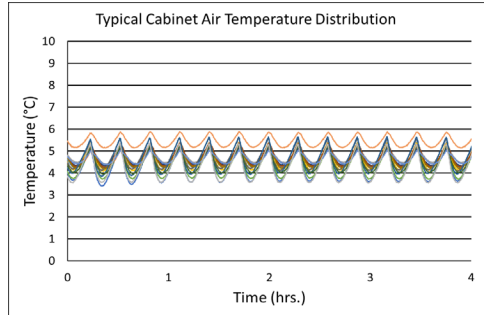
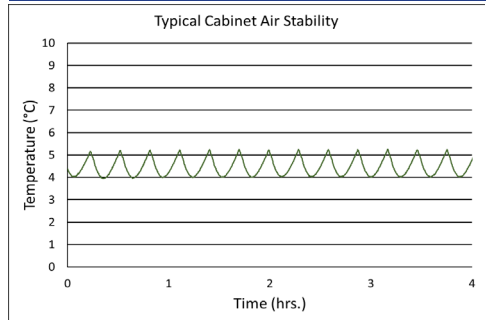

**Refrigeration System**

Compressor	Hermetic, high performance
Refrigerant	EPA SNAP compliant, R290, propane
Condenser	Fin and tube design, high efficiency fan
Evaporator	Fin and tube design, high efficiency fan
Defrost	Cycle optimized, zero energy

**Performance**

Uniformity <sup>1</sup> (Cabinet air)	+/- 0.9°C
Stability <sup>2</sup> (Cabinet air)	+/- 1.0°C
Maximum temperature variation (Cabinet air) <sup>3</sup>	+/-1.2°C
Temperature rise after 8 sec door openings	Temperature did not exceed 6.5°C at any probe for all required NSF/ANSI 456 testing protocols <sup>4</sup>
Recovery after 3 min door opening	All probes recover to under 8°C within 4.3 min.
Energy consumption	1.25 KWh/day <sup>4</sup>
Average heat rejection	1.97 KWh/day (280BTU/h) <sup>4</sup>
Noise pressure level (dBA)	48 or less installed
Pull down time to 4°C nominal operating temp	30 min

**Controller, Configuration, Alarms and Monitoring**

Controller technology	Parametric, microprocessor, LED display with 0.1°C resolution
Temperature setpoint range	1°C to 10°C (Controller settings must remain unaltered to ensure thermal performance compliant with NSF/ANSI 456 Standard for Vaccine Storage requirements)
Display probe	Calibrated, stainless steel
External alarm connection	State switching remote alarm contacts
Alarms	Visual and audible indicators
Alarms	High / Low temperature, compliant with alarm requirements defined in the NSF/ANSI 456 Standard for Vaccine Storage
Simulator ballast	Glass bead thermal media

Performance data acquired at 22°C ambient, using NSF/ANSI 456 compliant validation ballast probes, empty chamber, during stabilized steady state operation and a DAQ sampling rate of one measurement every 10 seconds

- 1 - Uniformity is defined as the maximum variance in temperature across all probes at any point in time over the testing period
- 2 - Stability is defined as the maximum variance in temperature experienced by any single probe over the testing period
- 3 - Temperature performance for all loaded and unloaded door opening protocols, all alarm, controller and probe requirements as defined in the NSF/ANSI 456 standard for vaccine storage
- 4 - Data per Energy Star test results or equivalent testing and calculation. Heat rejection based on daily averages, not continuous operation. Performance exceeds Energy Star requirements.

**Product Data Sheet**

Upright 16 cu. ft. Glass Door Refrigerator, High Performance  
 - Certified to NSF/ANSI 456 Standard for Vaccine Storage

**Images**



**Dimensions**

	Width	Depth	Height	Door Swing	Total open Depth
Exterior	25"	26"	79"	23 1/8"	49 1/4"
Interior	20"	19 1/8"	48 1/8"		

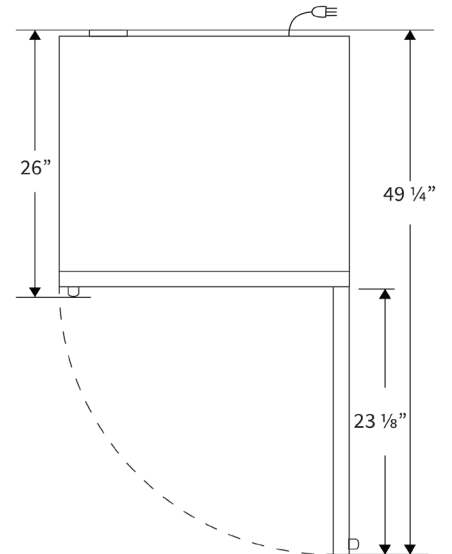
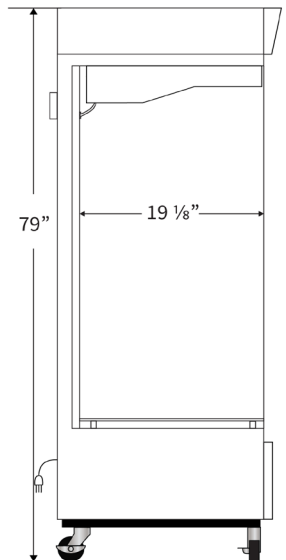
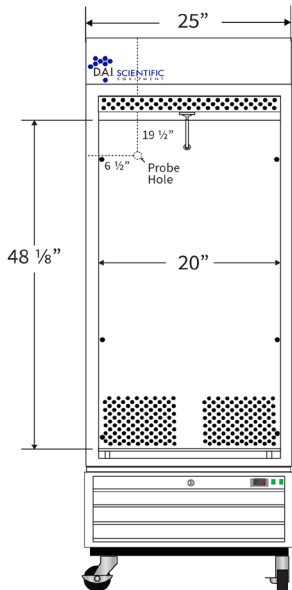

**Contact**

Phone 866-705-4749  
 Email [customerservice@daiscientific.com](mailto:customerservice@daiscientific.com)  
 Rev\_10042022