

Front View

Side View

Top View

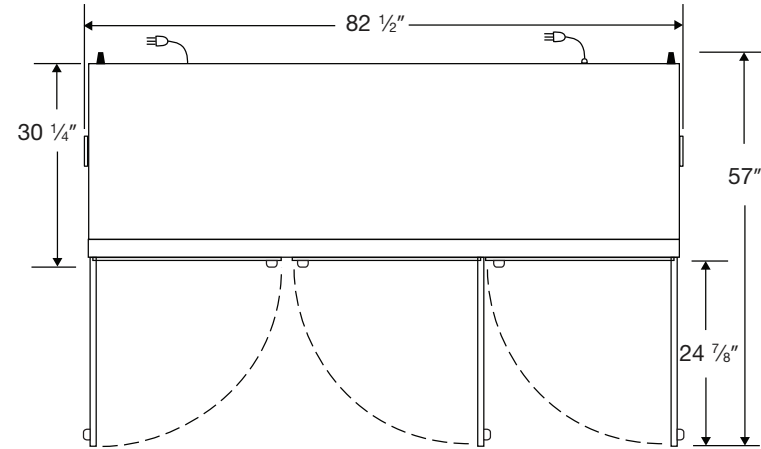
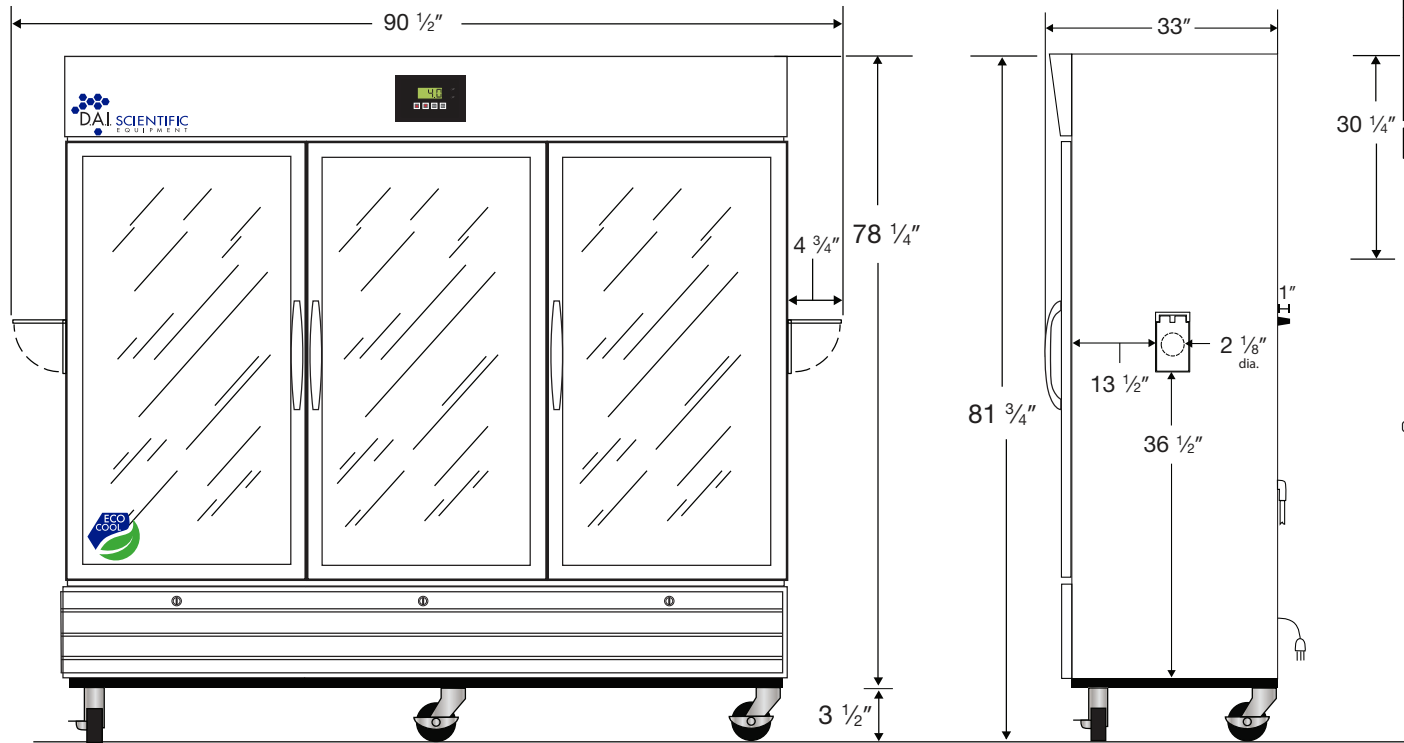

115VAC/60Hz/1PH  
NEMA-5-15P

Cu. Ft	Defrost	Door	Int Door	Shelves	W"	D"	H"	Refrigerant	H.P.	Amps	Weight
72	Cycle	3 Glass	0	12 Adj	82 1/2	34	81 3/4	R290	1/2	7.5	693 lbs.